

TM270W

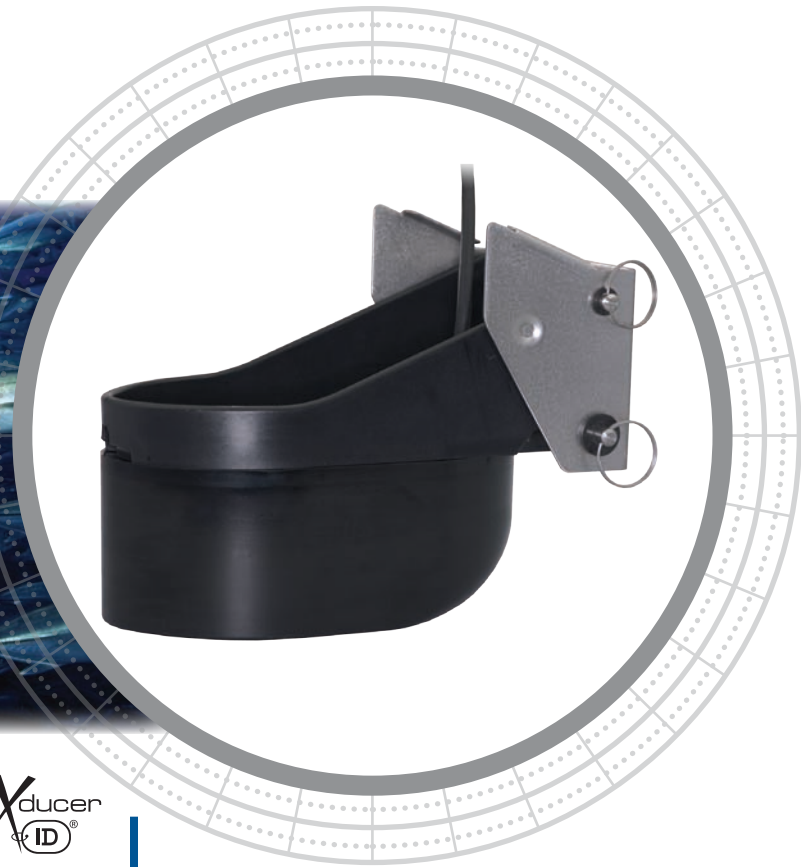

Wide-Beam Performance on Your Transom

The SS270W, 1 kW, twin, wide-beam is now available as a transom-mount for larger trailered boats with outboards and I/O's. The TM270W's high-performance mounting bracket is easy-to-install and has a streamlined shape that delivers high-speed performance up to 30 knots (35 MPH).

See the Wider Picture

The TM270W gives you four times the beamwidth at 200 kHz than other high-performance transducers. Since the width of the beams are the same at both frequencies, a split-screen fishfinder display will clearly show the same water column and bottom coverage. Fish may also appear as arches. More fish will be marked while cruising, trolling, drifting, or at anchor. Get the wider picture on your sounder with the TM270W.

- **Tuna/Marlin Fishermen**—Detect bait and gamefish in the upper water column that would go unseen with a traditional narrow-beam transducer.
- **Downrigger Fishermen**—Have the ability to see your downrigger ball and the lines attached to it. Get a closer look at a fish strike on your echosounder screen.
- **Jig Fishermen**—Seeing your jigs on the echosounder screen while bottom fishing can help avoid bottom hang-ups. Seeing a tuna attack your jigs on the echosounder display lets you reel up loose lines before it is too late.

Transom-Mount Wide-Beam 1 kW

Fishing Applications

- Blue-water trolling using both 50 kHz and 200 kHz
- Bait and game fish marking in shallow to mid-water
- Wreck and structure finding on the continental shelf
- Vertical deep jigging
- Downrigger fishing in saltwater or deep-water lakes

Features

- Top-of-the-line wide-beam transom-mount
- Designed for tuna or marlin fishing
- Identical wide 25° beams at 50 kHz and 200 kHz
- Interfaces to any 600 W or 1 kW sounder
- Depth and fast-response water-temperature sensor
- Kick-up assembly locks in the "up" position and will not damage the transom
- Accommodates transom angles between 3° and 21°
- Urethane housing
- Boat Size: Up to 12 m (40')



Sensing Technology

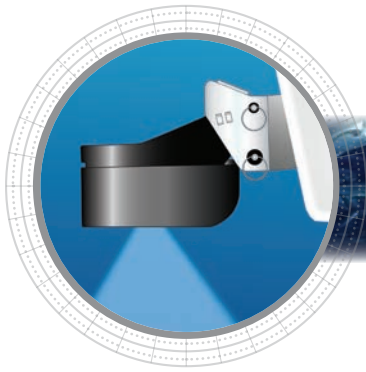



TM270W



Technical Information

50 kHz-AWlq / 200 kHz-BM

Number of Elements and Configuration		
Beamwidth (@-3 dB)	25°	25°
RMS Power (W)	1 kW	1 kW
TVR	161 dB	167 dB
RVR	-175 dB	-194 dB
FOM	-19 dB	-27 dB
Q	4	15
Impedance	200 Ω	90 Ω

MAXIMUM DEPTH RANGE

50 kHz	200 kHz
400 m to 610 m (1,350' to 2,000')	100 m to 180 m (330' to 600')

BEAM DIAMETER VS DEPTH

Depth	50 kHz	200 kHz
9 m (30')	4 m (13')	4 m (13')
30 m (100')	14 m (45')	14 m (45')
122 m (400')	55 m (180')	55 m (180')
305 m (1,000')	137 m (450')	137 m (450')

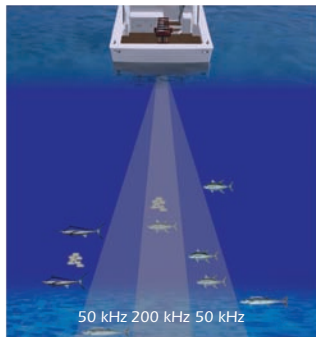

Standard 1 kW transducer
19° at 50 kHz, 6° at 200 kHz

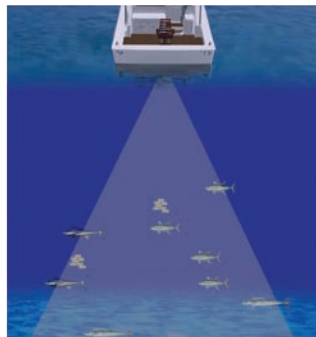

TM270W twin wide-beam transducer
Identical 25° beamwidths at 50 kHz and 200 kHz

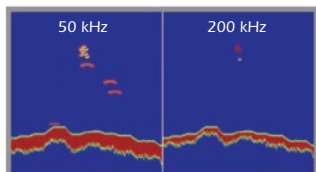

Different number of fish detected—
fish and bottom do not appear the same

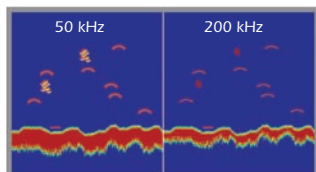

See the same targets at both frequencies—
allows for easier species and bottom identification

SPECIFICATIONS

Weight: 4 kg (8.9 lb)
Hull Deadrise: Up to 28°
Acoustic Window: Urethane

DIMENSIONS

TM270W Housing

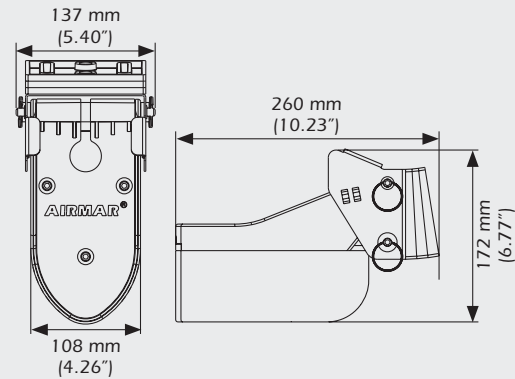

TM270W Transducer

